

REV.	Description	REV.	Description
0.0	V0.0首次发行 史亚萍 2021/1/21		
0.1	增加SOC补充说明 史亚萍 2021/05/24		
0.2	配件包更改为自攻螺钉, 取消底座与从控直接的螺丝连接 删除TUV认证, 增加UKCA/UKNI 俞小莉 2021/09/01		

品名	说明书 Triple Power 3.0 英文 SOLAX				浙江艾罗网络能源技术股份有限公司 SolaX Power Network Technology (Zhe jiang) Co.,Ltd.
料号	614.00519.02				
单位	mm	页次			

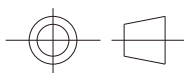
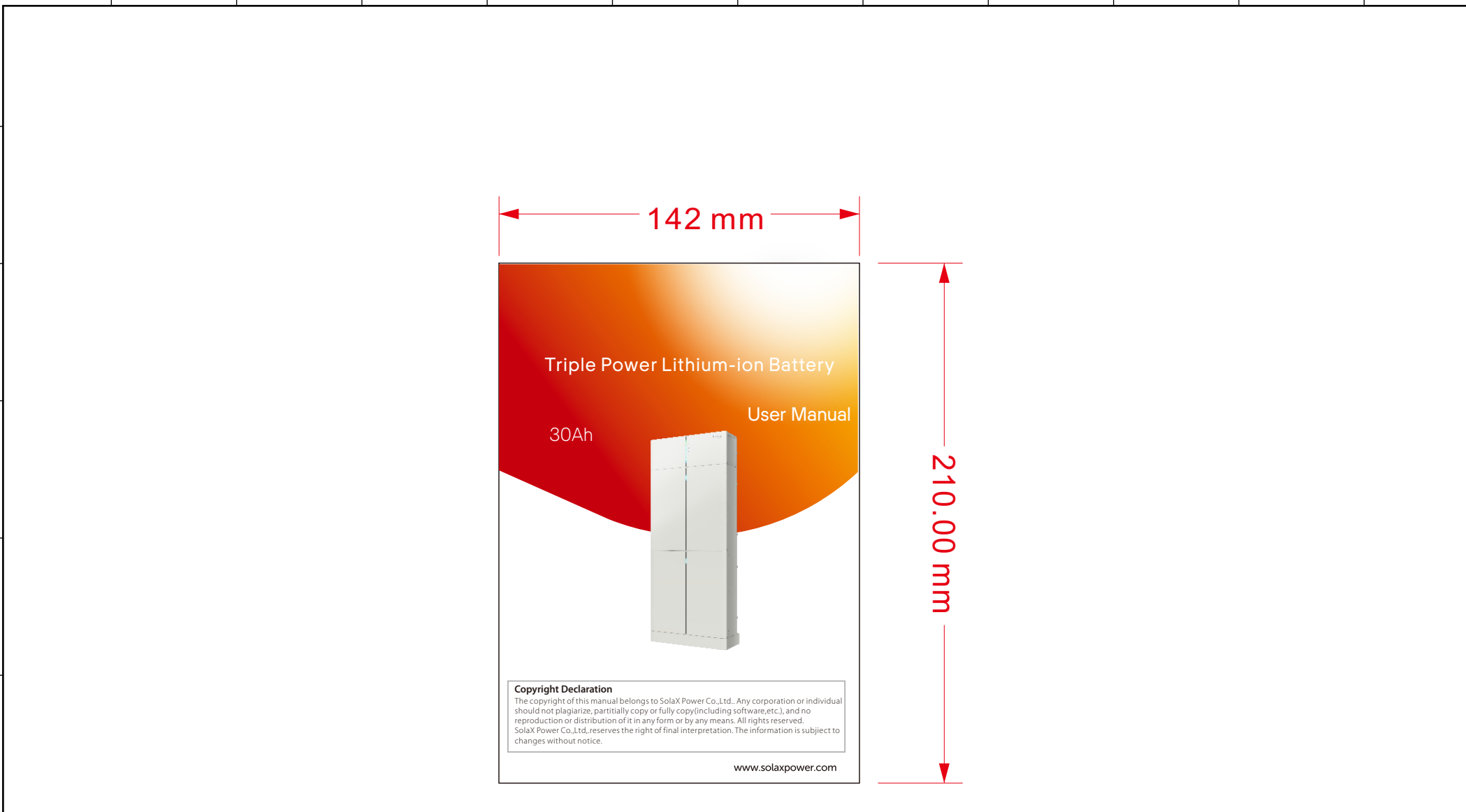

- 技术要求:
- 1.封面封底157g铜版纸覆哑膜彩打, 内部纸80g双胶纸黑白印刷, 正反打印
 - 2.装订方式:页码大于60需用胶装
 - 3.未注尺寸公差按 +- 1.5mm
 - 4.图面、字体印刷清晰、无毛边、不起边、油墨不脱落
 - 5.字体颜色为PANTONE Black C, 无边框, 底色为白色
 - 6.符合RoHS要求

品名	说明书 Triple Power 3.0 英文 SOLAX		设计	史亚萍	2021/01/21
材料	NA		审核	葛久远	2021/01/21
料号	614.00519.02		核准	葛久远	2021/01/21
单位	mm	页次		浙江艾罗网络能源技术股份有限公司	

Triple Power Lithium-ion Battery

User Manual

30Ah



Solax Power Network Technology(Zhe jiang) Co., Ltd.

No.288 Shizhu Road, Tonglu Economic Development Zone,
Tonglu City, Zhejiang province, China.

Tel: +86 0571-56260011

E-mail: info@solaxpower.com

614.00519.02

Copyright Declaration

The copyright of this manual belongs to SolaX Power Network Technology(Zhe jiang) Co., Ltd. Any corporation or individual should not plagiarize, partially or fully copy (including software,etc.), and no reproduction or distribution of it in any form or by any means. All rights reserved. SolaX Power Network Technology (Zhe jiang) Co.,Ltd. reserves the right of final interpretation.

www.solaxpower.com

Contents

1	NOTE ON THIS MANUAL.....	1
1.1	SCOPE OF VALIDITY.....	1
1.2	TARGET GROUP.....	1
1.3	SYMBOLS USED.....	1
2	SAFETY.....	2
2.1	SAFETY INSTRUCTIONS.....	2
2.1.1	GENERAL SAFETY PRECAUTIONS.....	2
2.1.2	EXPLANATION OF SYMBOLS.....	3
2.2	RESPONSE TO EMERGENCY SITUATIONS.....	4
2.2.1	LEAKING BATTERIES.....	4
2.2.2	FIRE.....	4
2.2.3	WET BATTERIES AND DAMAGED BATTERIES.....	4
2.3	QUALIFIED INSTALLER.....	5
3	PRODUCT INTRODUCTION.....	6
3.1	PRODUCT OVERVIEW.....	6
3.1.1	DIMENSIONS AND WEIGHT.....	6
3.1.2	INSTALLATION SPACE.....	7
3.1.3	APPEARANCE.....	8
3.2	BASIC FEATURES.....	10
3.2.1	FEATURES.....	10
3.2.2	CERTIFICATIONS.....	10
3.3	SPECIFICATIONS.....	11
3.3.1	T-BAT SYS-HV CONFIGURATION LIST.....	11
3.3.2	PERFORMANCE.....	11
4	INSTALLATION.....	12
4.1	INSTALLATION PREREQUISITES.....	12
4.2	SAFETY GEAR.....	12
4.3	TOOLS.....	13
4.4	INSTALLATION.....	13
4.4.1	CHECK FOR TRANSPORT DAMAGE.....	13
4.4.2	UNPACKING.....	13
4.4.3	ACCESSORIES.....	14
4.4.4	OVERALL INSTALLATION.....	16
4.4.5	INSTALL BMS TO BATTERY MODULE.....	19

- 4.5 CABLE CONNECTION..... 22
 - 4.5.1 CONNECTING CABLES TO INVERTER..... 22
 - 4.5.2 CONNECTING THE COMM CIOMMUNICATION CABLE..... 25
 - 4.5.3 CONNECTING THE GROUND WIRE..... 25
 - 4.5.4 CONNECTING CABLES TO BATTERY MODULES..... 26
- 5 COMMISSIONING..... 32
 - 5.1 COMMISSIONING..... 32
 - 5.2 STATUS INDICATORS..... 33
 - 5.2.1 BMS(MC0600)..... 33
 - 5.2.2 BATTERY MODULE (HV10230)..... 34
 - 5.3 SHUTTING DOWN T-BAT SYSTEM..... 35
- 6 TROUBLESHOOTING..... 36
 - 6.1 TROUBLESHOOTING..... 36
- 7 DECOMMISSIONING..... 36
 - 7.1 DISMANTLING THE BATTERY..... 38
 - 7.2 PACKAGING..... 38
- 8 MAINTENANCE..... 39
- 9 DISCLAIMER..... 40

1 Note on this Manual

1.1 Scope of Validity

This manual is an integral part of the T-BAT Series. It describes the assembly, installation, commissioning, maintenance and failure of the product. Read carefully prior to operation.

T-BAT BMS
MC0600
T-BAT Module
HV10230





Note: There are 4 models of the T-BAT system, which include the BMS and battery module(s). Refer to section 3.3.1 T-BAT SYS-HV Configuration List on page 11 for detailed models.

1.2 Target Group

This manual is for qualified electricians. The tasks described in this manual may only be performed by qualified electricians.

1.3 Symbols Used

The following types of safety instructions appear in this document and are described below:

- 
DANGER!
 “DANGER” indicates a hazardous situation which, if not avoided, will result in serious injury or death.
- 
WARNING!
 “WARNING” indicates a hazardous situation which, if not avoided, could result in serious injury or death.
- 
CAUTION!
 “CAUTION” indicates a hazardous situation which, if not avoided, could result in minor or moderate injury.
- 
NOTE!
 “NOTE” provides tips that are valuable for the optimal operation of your product.

2 Safety

2.1 Safety Instructions

For safety reasons, installers are responsible for familiarizing themselves with the contents of this manual and all warnings before performing installation.

2.1.1 General Safety Precautions



WARNING!

Do not crush or impact the battery, and always dispose of it according to safety regulations.

Observe the following precautions:

- Risks of explosion:
 - Do not subject the battery module to heavy impacts.
 - Do not crush or puncture the battery module.
 - Do not dispose of the battery module in a fire.
- Risks of fire:
 - Do not expose the battery module to temperatures in excess of 140°F.
 - Do not place the battery module near a heat source, such as a fireplace.
 - Do not expose the battery module to direct sunlight.
 - Do not allow the battery connectors to touch conductive objects such as wires.
- Risks of electric shock:
 - Do not disassemble the battery module.
 - Do not touch the battery module with wet hands.
 - Do not expose the battery module to moisture or liquids.
 - Keep the battery module away from children and animals.
- Risks of damage to the battery module:
 - Do not expose the battery module to liquids.
 - Do not subject the battery module to high pressures.
 - Do not place any objects on top of the battery module.

T-BAT SYS-HV should only be installed for residential applications and is not for commercial applications.















CAUTION!

If the battery is not installed within one month after receipt, it must be charged for maintenance.

Wasted batteries must be discarded according to local regulations.

2.1.2 Explanation of Symbols

Symbol	Explanation
	The inverter complies with the requirements of the applicable CE guidelines.
	The inverter complies with the requirements of the applicable UKCA guidelines.
	The inverter complies with the requirements of the applicable UKNI guidelines.
	The battery system must be disposed of at a proper facility for environmentally-safe recycling.
	The battery system should not be disposed of together with household waste. Disposal information can be found in the enclosed documentation.
	Wear protective glasses.
	Observe enclosed documentation.
	Keep the battery system away from open flames or ignition sources.
	Keep the battery system away from children.
	Danger of high voltages.
	Danger. Risk of electric shock.
	The battery module may explode.

2.2 Response to Emergency Situations

2.2.1 Leaking Batteries

If the battery leaks electrolyte which is corrosive, avoid contact with the leaking liquid or gas. Direct contact may lead to skin irritation or chemical burns. If one is exposed to the leaked substance, perform these actions:

Accidental inhalation of harmful substances: Evacuate from the contaminated area, and seek medical attention immediately.

Eye contact: Rinse eyes with flowing water for 15 minutes, and seek medical attention immediately.

Dermal contact: Wash the affected area thoroughly with soap and water, and seek medical attention immediately.

Ingestion: Induce vomiting, and seek medical attention immediately.

2.2.2 Fire

In case of a fire, ensure that an ABC or a carbon dioxide extinguisher is nearby.



WARNING!

The battery module may catch fire when heated above 302°F.

If a fire breaks out where the battery module is installed, perform these actions:

- 1) Extinguish the fire before the battery module catches fire
- 2) If the battery module catches fire, do not try to extinguish the fire. Evacuate immediately.



WARNING!

If the battery module catches fire, it will produce noxious and poisonous gases. Do not approach.

2.2.3 Wet Batteries and Damaged Batteries

If the battery module is wet or submerged in water, do not try to access it.

If the battery module seems to be damaged, it is not fit for use and may pose a danger to people or property.

Please pack the battery in its original packaging, and return it to SolaX or your distributor.



CAUTION!

Damaged batteries may leak electrolyte or produce flammable gas. If you suspect such damage, immediately contact SolaX for advice and information.

2.3 Qualified Installer



WARNING!

All operations of T-BAT SYS-HV relating to electrical connection and installation must be carried out by qualified personnel.

A skilled worker is defined as a trained and qualified electrician or installer who has all of the following skills and experience:

- Knowledge of the functional principles and operation of grid-tied systems
- Knowledge of the dangers and risks associated with installing and using electrical devices and acceptable mitigation methods
- Knowledge of the installation of electrical devices
- Knowledge of and adherence to this manual and all safety precautions and best practices

3 Product Introduction

3.1 Product Overview

For safety reasons, installers are responsible for familiarizing themselves with the contents of this manual and all warnings before performing installation.

3.1.1 Dimensions and Weight

A battery management system (BMS) is an electronic system that manages a rechargeable battery.

A battery module is a type of electrical battery which can be charged or discharged into a load.

A battery system includes the BMS and battery module(s).

	Base Mounting	MC0600	HV10230
Length	482mm	482.5mm	482.5mm
Width	167mm	173.5mm	471.5mm
Height	71mm	153mm	153mm
Weight	2.5KG	7.5KG	34.5KG

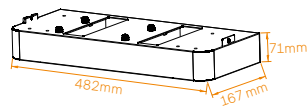

Base Mounting

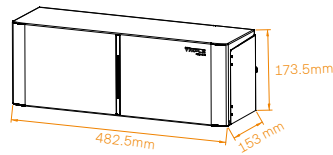

BMS (MC0600)

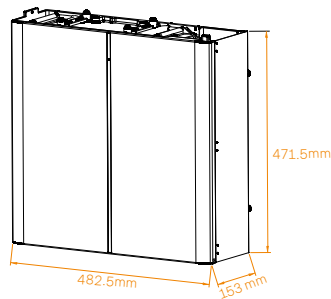

Battery Module (HV10230)

3.1.2 Installation Space

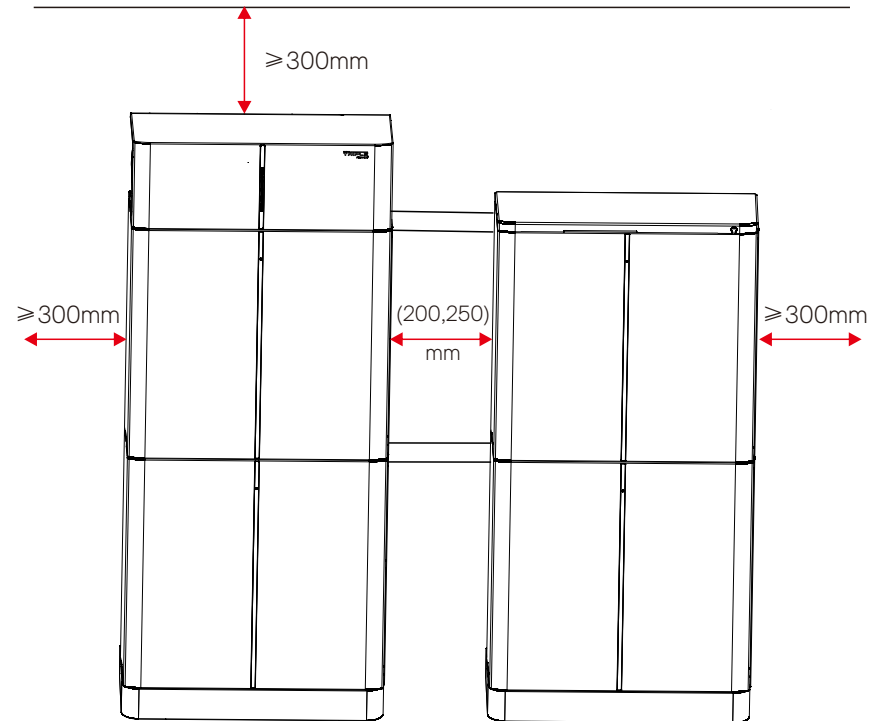

3.1.3 Appearance

- Section view of MC0600

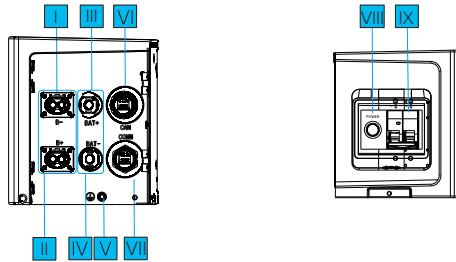

Object	Mark	Description
I	B-	Connector B- of BMS to B- of battery module
II	B+	Connector B+ of BMS to B+ of battery module
III	BAT+	Connector BAT+ of BMS to BAT+ of inverter
IV	BAT-	Connector BAT- of BMS to BAT- of inverter
V	⊕	GND
VI	CAN	Connector CAN of BMS to CAN of inverter
VII	COMM	Connector COMM of BMS to COM1 of battery module
VIII	POWER	Power Button
IX	ON/OFF	Circuit Breaker

- Section view of HV10230

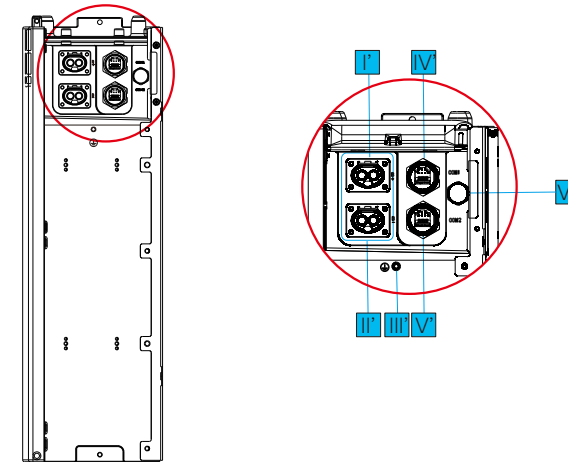

Object	Mark	Description
I'	B+	Connector B+ of BMS, or B- of upper/next battery module
II'	B-	Connector B- of BMS, or B+ of upper/next battery module
III'	⊕	GND
IV'	COM1	Connector to BMS COMM, or COM2 of next battery module
V'	COM2	Connector to COM1 of next battery module
VI'	/	Air Valve

3.2 Basic Features

3.2.1 Features

The T-BAT SYS-HV is one of the most advanced energy storage systems on the market today, incorporating state-of-the-art technology, high reliability, and convenient control features shown as below:

- 90% DOD
- 95% Battery Roundtrip Efficiency
- Cycle Life > 6000 Cycles
- Secondary Protection by Hardware
- IP65 Protection Level
- Safety & Reliability
- Small Occupied Area
- Floor or Wall Mounting

3.2.2 Certifications

BAT system safety	CE, RCM, IEC 62619
UN number	UN 3480
Hazardous materials classification	Class 9
UN transportation testing requirements	UN 38.3
International protection marking	IP 65

3.3 Specifications

3.3.1 T-BAT SYS-HV Configuration List

No.	Model	BMS	Battery Module	Energy(kWh)	Voltage (V)
1	T-BAT H 3.0	MC0600×1	HV10230×1	3.1	90-116
2	T-BAT H 6.0	MC0600×1	HV10230×2	6.1	180-232
3	T-BAT H 9.0	MC0600×1	HV10230×3	9.2	270-348
4	T-BAT H 12.0	MC0600×1	HV10230×4	12.3	360-464

3.3.2 Performance

Model	MC0600+ HV10230×1	MC0600+ HV10230×2	MC0600+ HV10230×3	MC0600+ HV10230×4
Nominal Voltage (Vdc)	102.4	204.8	307.2	409.6
Operating Voltage (Vdc)	90-116	180-232	270-348	360-464
Nominal Capacity (Ah) ^①	30	30	30	30
Nominal Energy (kWh) ^①	3.1	6.1	9.2	12.3
Usable Energy (kWh) ^②	2.8	5.5	8.3	11.0
Max. Charge/Discharge Current (A) ^③	30	30	30	30
Recommend Charge/Discharge Current (A)	25	25	25	25
Standard Power (kW)	2.55	5.1	7.65	10.2
Max. Power (kW)	3.1	6.1	9.2	12.3
Battery Roundtrip Efficiency(0.2C, 25°C/77°F)	95%			
Expected Lifetime (25°C/77°F)	10 years			
Cycle Life 90% DOD, (25°C/77°F)	6000 cycles			
Available Charge/Discharge Temperature Range	-30°C--50°C(with heating function) ^④			
	-10°C--50°C(no heating function) ^⑤			
Storage Temperature	-20°C--50°C(3 months)			
	0°C--40°C(12 months)			
Ingress Protection	IP65			

- ** ^① Test conditions: 100% DOD, 0.2C charge & discharge @+25°C
^②90% DOD; System usable energy may vary with inverter different setting
^③Discharging: 0-5°C and 45-50°C will be rating; Charging: 0-15°C and 40-50°C will be rating
^④The battery can be discharged and charged at -30-0°C
^⑤The battery can be discharged and only can not be charged at -10-0°C

4 Installation

4.1 Installation Prerequisites

When assembling the system, avoid touching the battery terminal with any metal objects or bare hands. T-BAT SYS-HV provides a safe source of electrical energy when operated as designed. Potentially hazardous circumstances such as excessive heat or electrolyte leakage may occur under improper operating conditions, damage, misuse and abuse. The previous safety precautions and the warning messages described in this section must be observed. If any of the previous precautions are not fully understood, or if you have any questions, contact customer service for guidance. The Safety Section may not include all regulations for your region.

Ensure that the installation location meets the following conditions:

- The building is designed to withstand earthquakes
- The location is far from the sea to avoid salt water and humidity, over 0.62 miles
- The floor is flat and level
- There are no flammable or explosive materials, at a minimum of 3ft
- The ambience is shady and cool, away from heat and direct sunlight
- The temperature and humidity remain at a constant level
- There is minimal dust and dirt in the area
- There are no corrosive gases present, including ammonia and acid vapor

In practice, the requirements of battery installation may be different due to environment and locations.

In that case, follow up the exact requirements of the local laws and standards.



NOTE!
If the ambient temperature exceeds the operating range, the battery pack will stop operating to protect itself. The optimal temperature range for operation is 59°F to 86°F. Frequent exposure to harsh temperatures may deteriorate the performance and lifetime of the battery module.

4.2 Safety Gear

Installation and maintenance personnel must operate according to applicable federal, state, and local regulations as well as industry standards regarding product installation. Personnel must wear safety gear as indicated below in order to avoid short circuit and personal injury.



Insulated Gloves



Safety Goggles



Safety Shoes

4.3 Tools

These tools are required to install the T-BAT system.



Torque Screw Driver



Phillips-Screw Driver



Hexagon Wrench



Phillips-Head Screw Driver



Flat-Head Screw Driver



Torque Wrench

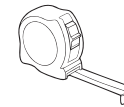

Tape Measure



Drill



Pencil or Marker

4.4 Installation

4.4.1 Check for Transport Damage

Ensure the battery is intact during and after transportation. If there are visible damages such as cracks, contact your dealer immediately.

4.4.2 Unpacking

Unpack the battery package by removing the packing tape. Ensure the battery modules and relevant items are complete. Refer to the packaging items in section 4.4.3 and check the packing lists carefully. If any items are missing, immediately contact SolaX or your distributor directly.



CAUTION!
According to regional regulations, several people may be required for moving the equipment.



WARNING!
Strictly follow the installation steps. SolaX will not be responsible for any injuries or loss incurred by incorrect assembly and operation.



NOTE!
When installing the battery for the first time, the manufacturing date between battery modules should not exceed 3 months.

4.4.3 Accessories

BMS (MC0600):

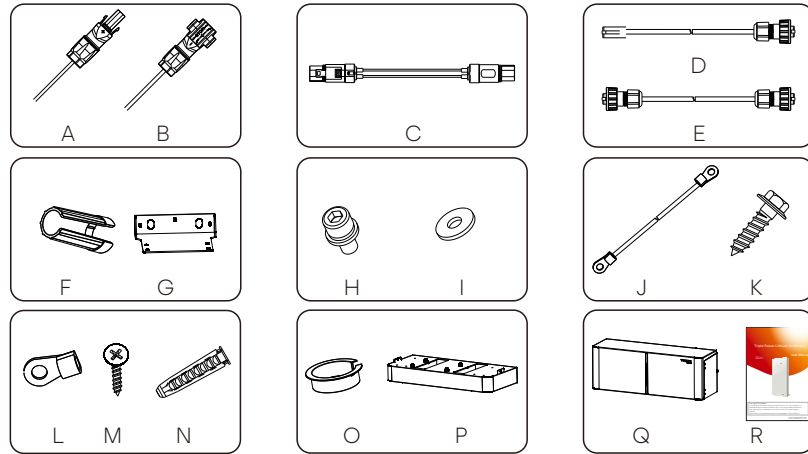

The table below lists the number of each component.

Object	Description	Quantity
A	Charging Cable (+) (2m)	1
B	Charging Cable (-) (2m)	1
C	Power Cable between BMS and Battery Module (0.12m)	1
D	CAN Communication Cable (2m)	1
E	COMM Communication Cable (0.2m)	1
F	Rotation Wrench	1
G	Wall bracket	1
H	M5 Combination Screw	2
I	Flat gasket	2
J	Earth Wire (150 mm)	1
K	Expansion Screw	2
L	Ring Terminal (for grounding)	1
M	ST3.9*16 Screw	2
N	Expansion tube	2
O	Guard Ring	2
P	Base Mounting	1
Q	BMS	1
R	User Manual	1

One Battery Module (HV10230×1):

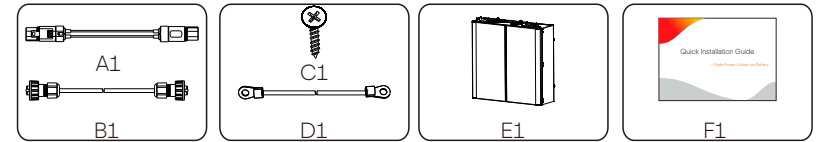

Accessories (1) of the three and four Battery Modules (HV10230×3/4):

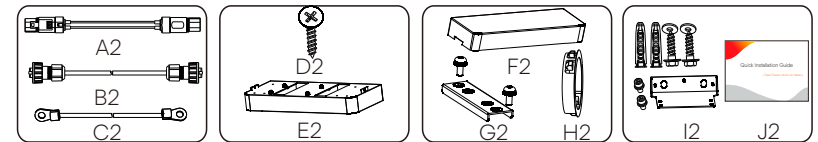

Accessories (2) of the three and four Battery Modules (Hv10230×3/4):

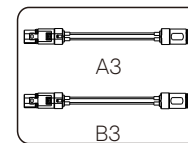

Note:A3×1 and B3×1 need to be purchased separately

The table below lists the number of each component.

Object	Description	Quantity
A1	Power Cable between BMS and Battery Module (690mm)	1
B1	COMM Communication Cable (600mm)	1
C1	ST3.9*16 Screw	2
D1	Earth Wire (450 mm)	1
E1	Battery Module	1
F1	Quick Installation Guide	1
A2	Power Cable between Battery Modules (1200mm)	1
B2	COMM Communication Cable of Battery Module (1200mm)	1
C2	Earth Wire (1200 mm)	1
D2	ST3.9*16 Screw	2
E2	Base Mounting	1
F2	Cover Plate	1
G2	Snap-fit	2
H2	Guard Ring	4
I2	Accessories of Wall bracket	1
J2	Quick Installation Guide	1
A3	Power Cable between Battery Modules or BMS (1200mm)	1
B3	Power Cable between BMS and Battery Module (1800mm)	1

4.4.4 Overall Installation

According to the battery used, choose the following corresponding form for installation.

1):MC0600×1+HV10230×1

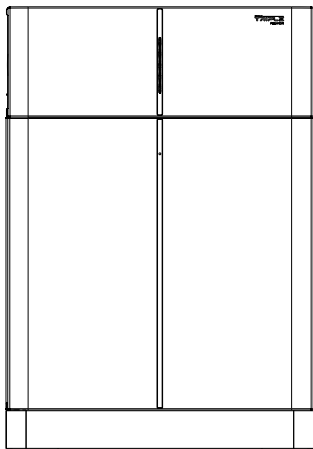

2):MC0600×1+HV10230×2

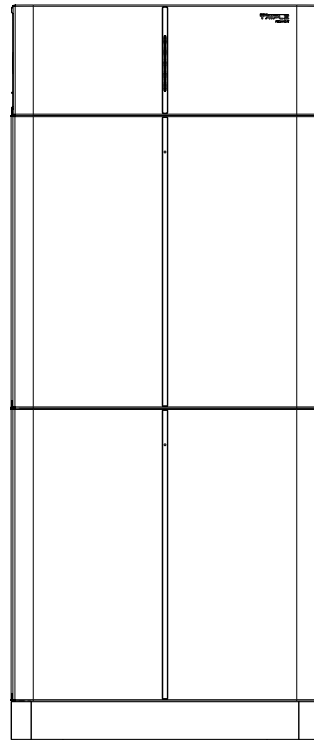

3):MC0600×1+HV10230×3

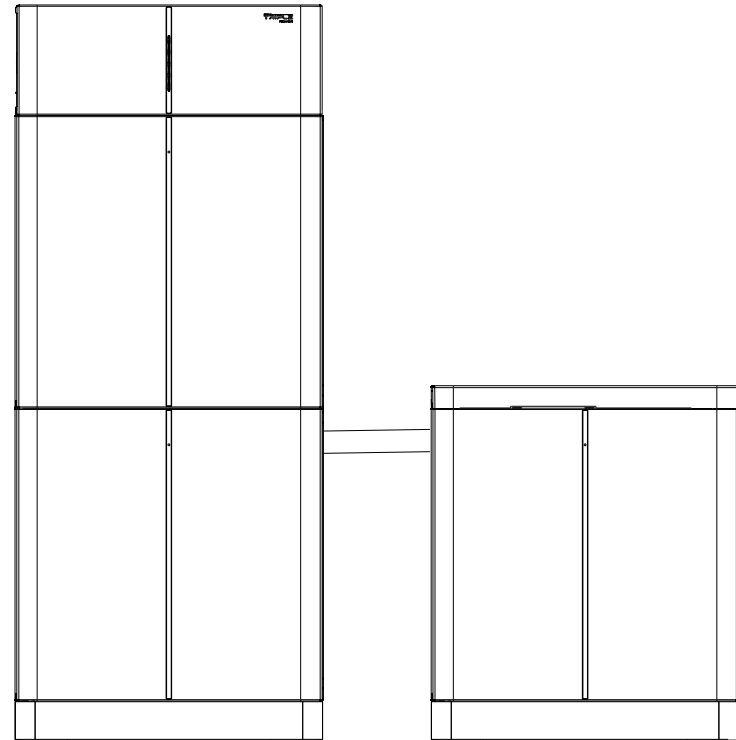

It is recommended to use corrugated pipe protect the outside cables between three and four battery modules.

4):MC0600×1+HV10230×4

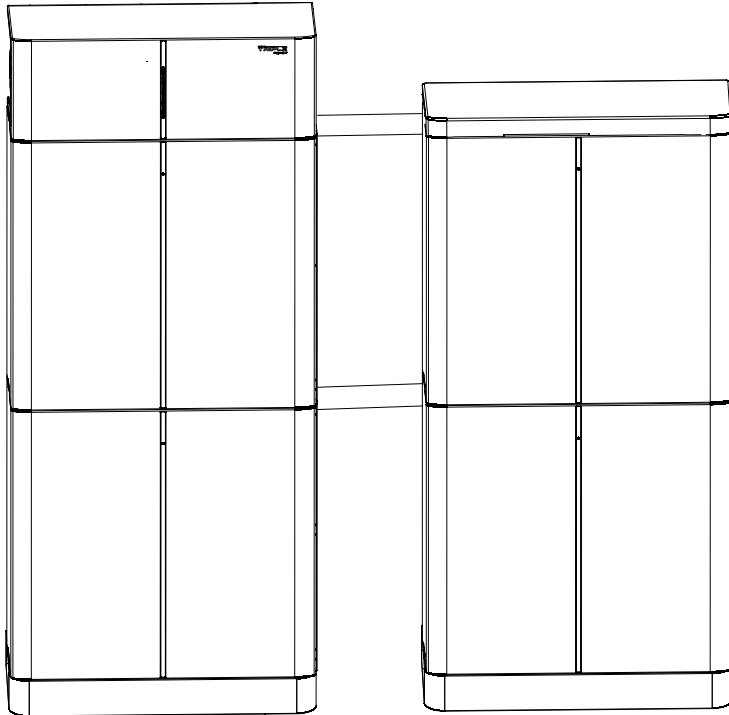

DANGER!

One T-BAT system can contain at most **four** battery modules. Connecting more than four battery modules will blow the fuse and the battery module(s) will be damaged. Ensure the number of battery module(s) meets this requirement.

4.4.5 Install BMS to Battery Module

Make sure the wall is strong enough to withstand the weight of battery.

Step 1: Fix the base mounting

- Firstly, adjust the height of the anchor bolt to make it parallel to the ground.
- Then place the base (193 ± 2)mm away from the wall and mark the diagonal hole position of the base.



Note!

Base mounting can be fixed after the balance of the battery is adjusted.

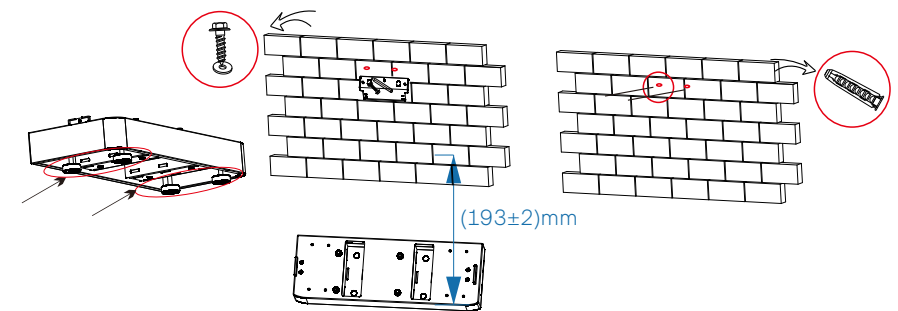

Step 2: Match the battery with the wall bracket (May change without notice)

- Lift the battery you need to the wall bracket, mark the location of the wall bracket.
- Drill holes with $\varnothing 10$ drill, make sure the holes are deep enough (at least 80mm) for installing and tightening the expansion tubes (N or K)
- Install the expansion tubes in the wall, and tighten the screws on the bracket by using the screw driller.
- Hang the battery over the wall bracket, move the battery close to the wall and Match it on the wall bracket

Take two battery modules as an example

Step 3: Match the battery with base mounting

- Place the battery module on top of base mounting.

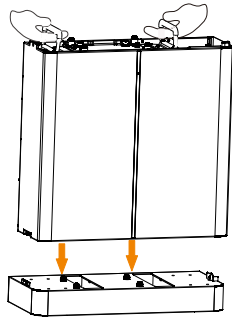

- Place the second one on top of the module and two sides are locked with ST3.9*16 screws.

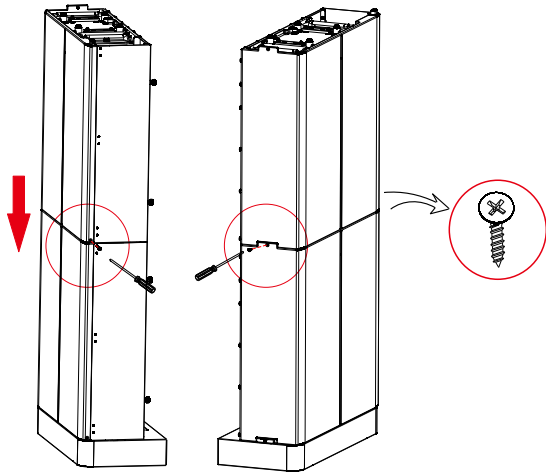

- Fix the battery module and wall bracket with expansion screws. (I,N and K)
One battery module or connected to the BMS, need to be installed a bracket to fix.

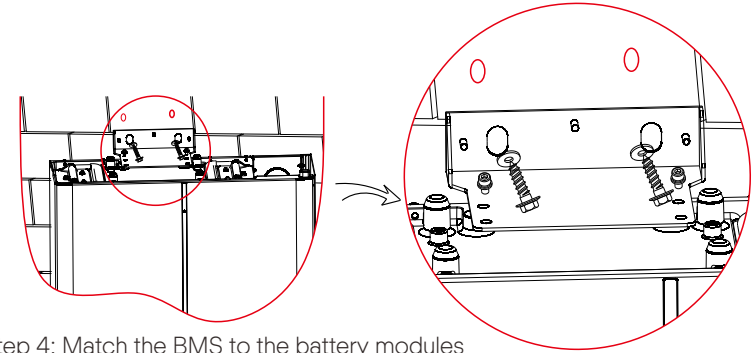

Step 4: Match the BMS to the battery modules

- Place the BMS on top of the module and two sides are locked with ST3.9*16 screws.

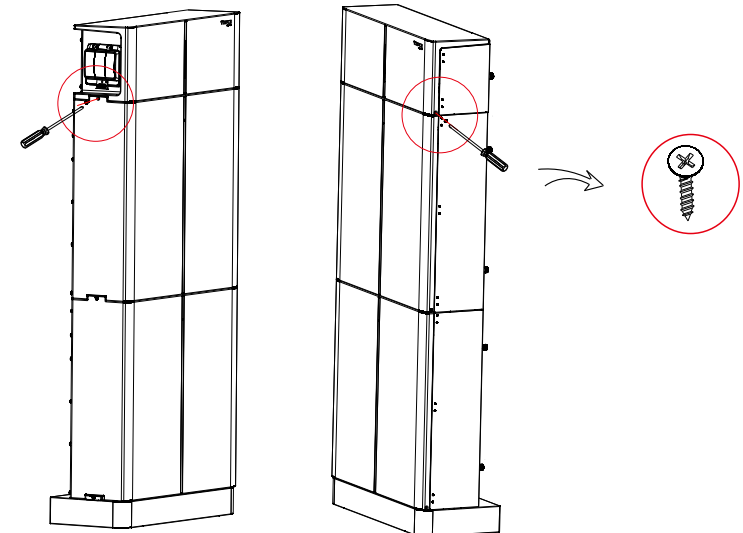

4.5 Cable Connection

Before connecting the cables, the right cover of the battery needs to be unscrewed by hand

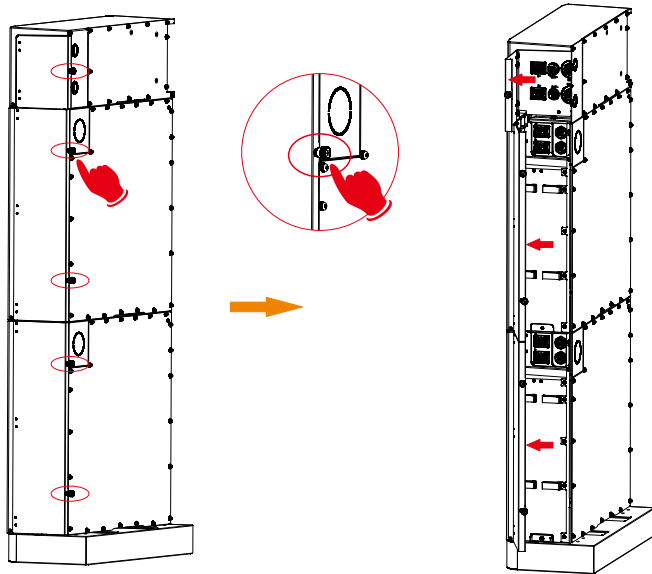

4.5.1 Connecting Cables to Inverter

BMS to Inverter:
 BAT+ to BAT+ (A:2000mm),
 BAT- to BAT- (B:2000mm),
 CAN to CAN (D:2000mm)

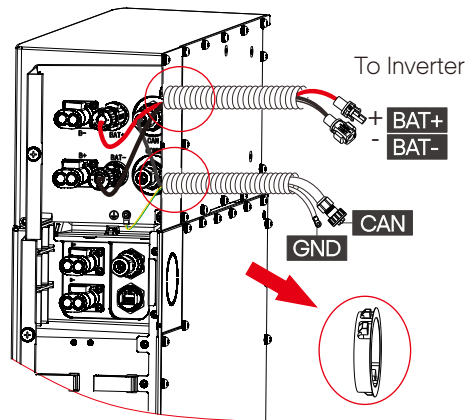

➤ Cable Connection Steps:

Step1. Strip the cable(A/B:2m) to 15mm.

Step2. Insert the stripped cable up to the stop (negative cable for DC plug(-) and positive cable for DC socket(+) are live). Hold the housing on the screw connection.

Step3. Press down the spring clamp until it clicks audibly into place (You should be able to see the fine wire strands in the chamber)

Step4. Tighten the screw connection(tightening torque:2.0±0.2Nm)

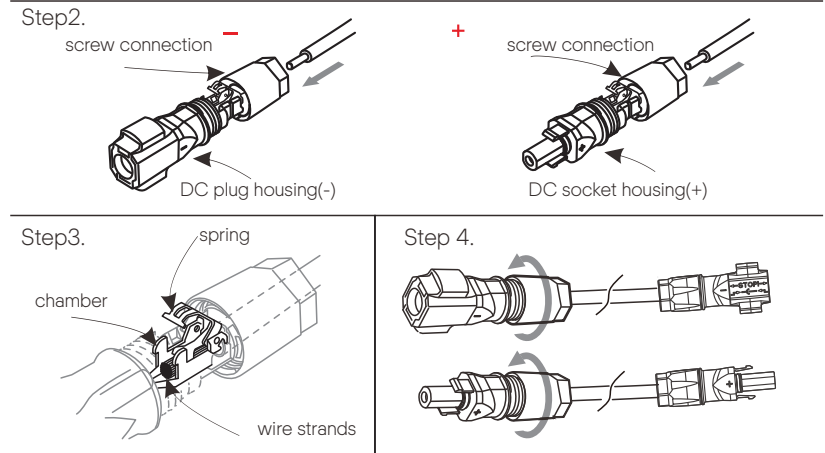

➤ Connecting the CAN Communication Cable

It is required for the BMS to communicate with the inverter for proper operation. Note that the CAN communication cable is shielded with steel tubes.

The wire order of the communication cable is the same as the CAN communication cable.

Sequence	1	2	3	4	5	6	7	8
CAN	/	GND	/	CAN_H	CAN_L	/	A1	B1

Notes for Unplugging Power Cables

CAUTION!
 Do not plug or unplug the power cables when the T-BAT system is on. Doing so could result in an arc discharge which could cause serious harm.

- 1) Shut down the T-BAT system (refer to Section 5.4 Shutting Down T-BAT System of User Manual on page 30)
- 2) Remove the lock cover
 - a. Pull the back end of the lock cover using a finger or an instrument.
 - b. Remove the lock cover and store for later use

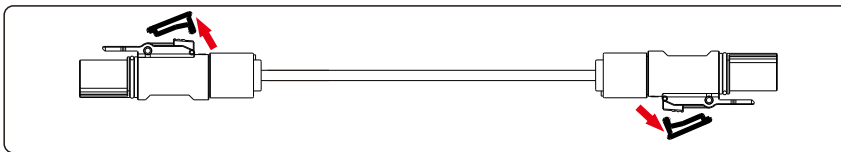
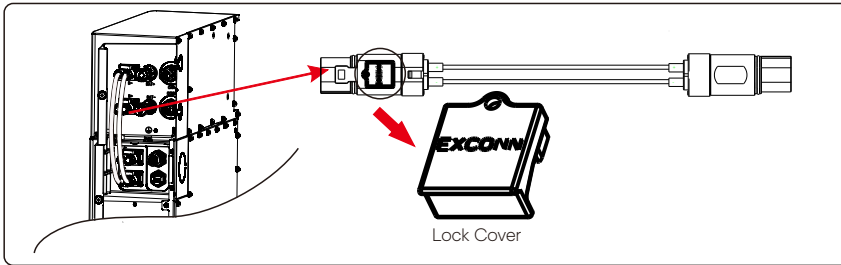

- 3) Push the plastic button on each end of the power cable in the direction of the arrow
- 4) Unplug the power cable

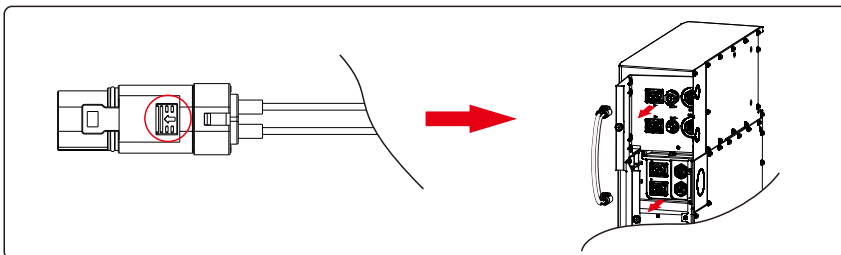

4.5.2 Connecting the COMM Communication Cable

- 1) Connect the COMM communication cable (E) from the right side of the BMS to the COM1 communication port that is on the right side of the battery module.
- 2) Connect the COM1 of the upper battery module on the right side to COM1 of the follow-up battery module.
- 3) Tighten the plastic screw nut which is set on the cable with a rotation wrench.

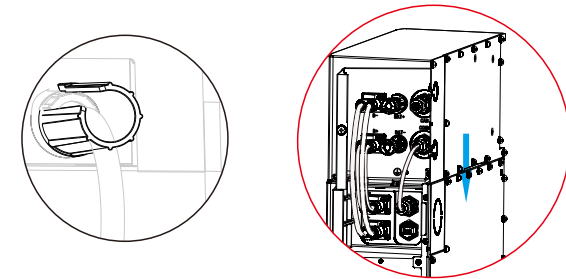

The wire order of the communication cable is as follows:

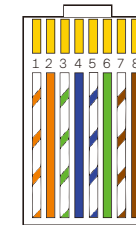
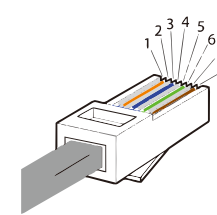

- 1) Orange stripes on white
- 2) Orange
- 3) Green stripes on white
- 4) Blue
- 5) Blue stripes on white
- 6) Green
- 7) Brown stripes on white
- 8) Brown

Sequence	1	2	3	4	5	6	7	8
COM1	VCC_1	GND	VCC_2	CANH	CANL	GND	N-	P+
COM2	VCC_1	GND	VCC_2	CANH	CANL	GND	N-	P+

4.5.3 Connecting the Ground Wire

For BMS and 3-4 battery modules:

Connect the ground wire from the BMS to the battery module

Note: 10AWG ground wire is required for grounding

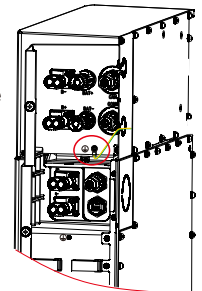

4.5.4 Connecting Cables to Battery Modules

Ensure that both ends of the cables are connected to the correct connector, which are on the right side of the BMS and battery module.

The BMS and battery module need to be grounded.

BMS to Slave1:
 B+ to B+ (C:1200mm),
 B- to B- (A1:690mm),
 COMM to COM1 (E:200mm)

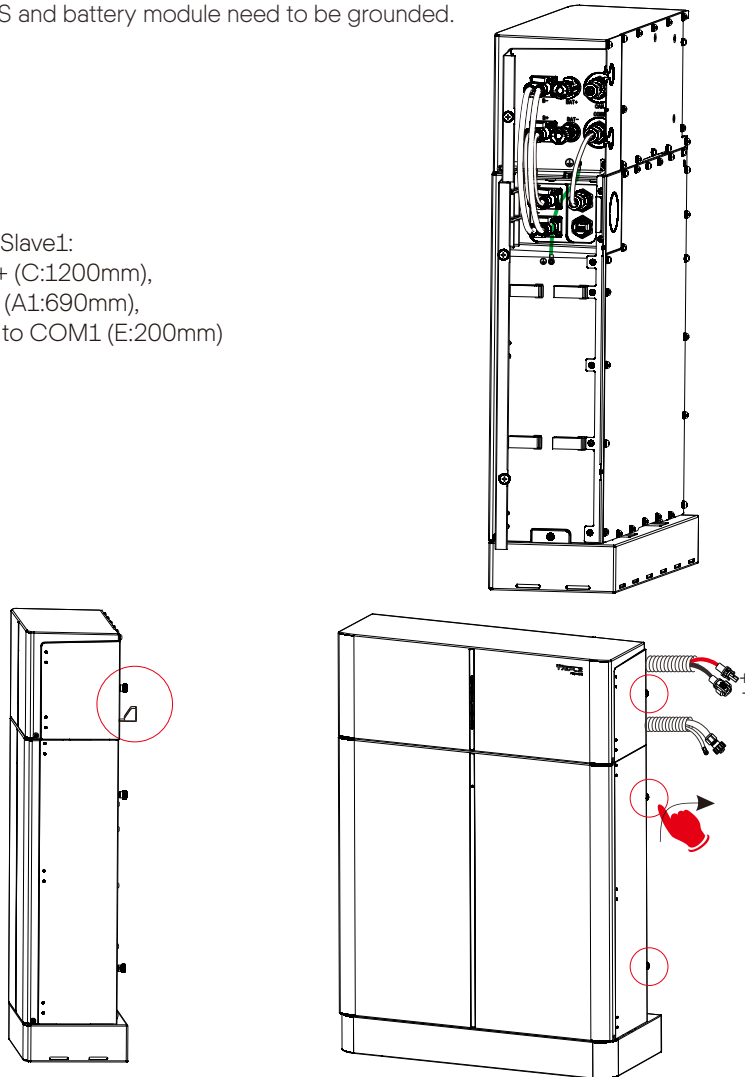

➤ For two battery modules:

Install a fixed wall bracket on the battery module, and then check to make sure the connections are securely locked.

The BMS and battery modules need to be grounded.
 Between battery modules need to be grounded.

BMS to Slave1: B+ to B+ (C:1200mm); COMM to COM1 (E:200mm)
 BMS to Slave2: B- to B- (A1:690mm)
 Slave1 to Slave2: B- to B+ (A1:690mm); COM2 to COM1 (B1:600mm)

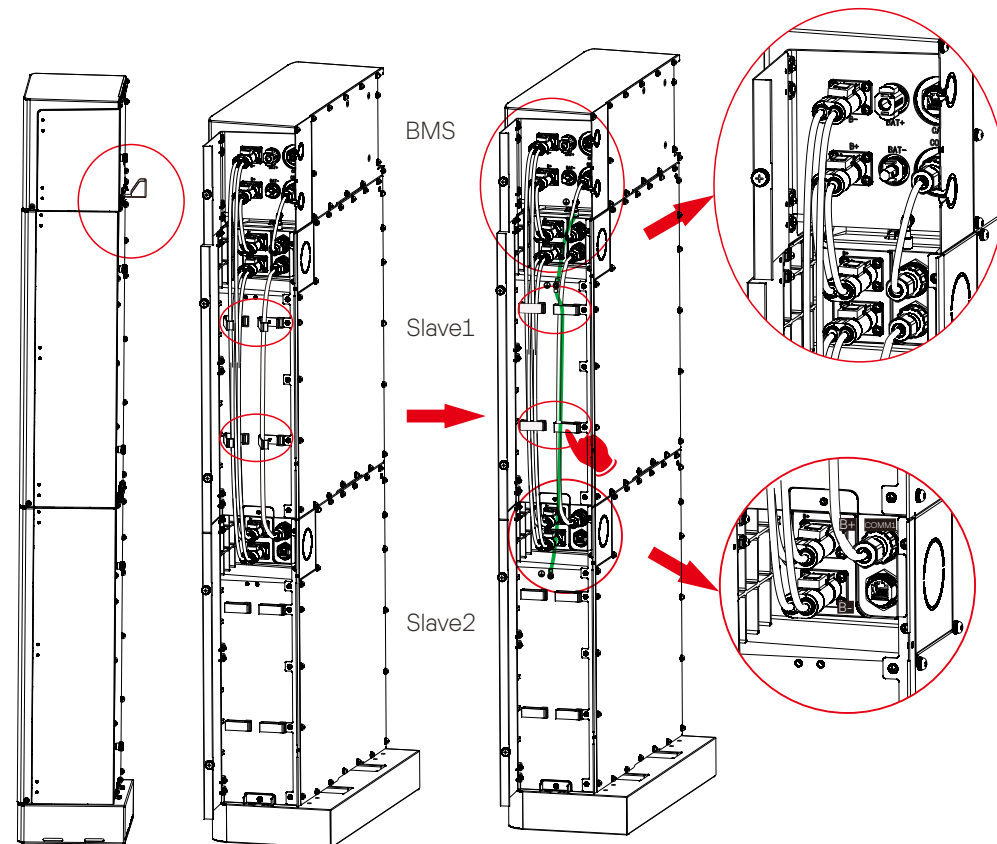

- For three battery modules:

Install a fixed wall bracket on the battery modules.

It (slave3 and slave4 if you need) is required to install the snap-fits to fix the cover plate.

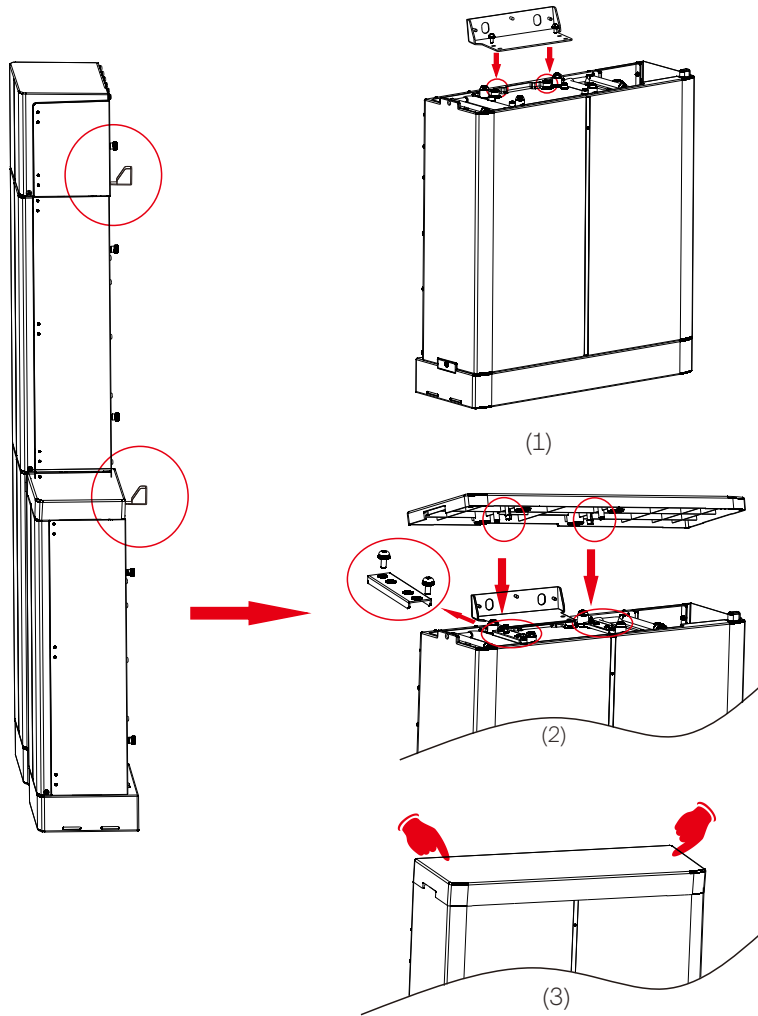

- Check to make sure the connections are securely locked.

BMS to Slave1:
B+ to B+ (C:120mm); COMM to COM1 (E:200mm);

BMS to Slave3:
B- to B- (B3:1.8m); Get the cables through corrugate pipe.

Slave1 to Slave2:
B- to B+ (A1:690mm); COM2 to COM1 (B1:600mm)

Slave2 to Slave3:
B- to B+ (A2:1.2m); COM2 to COM1 (B2:1.2m); Get the cables through corrugate pipe.

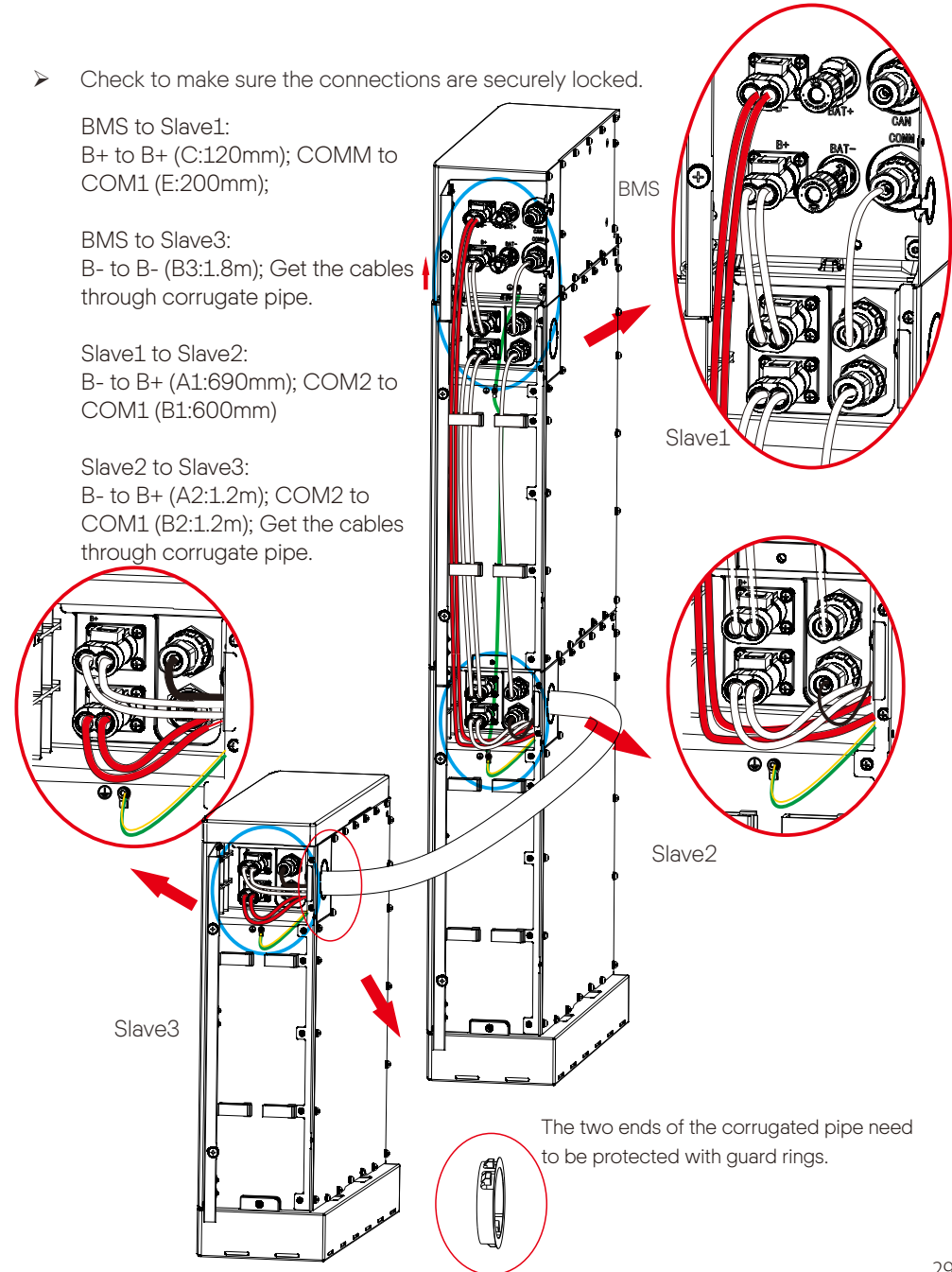

- For four battery modules:

Install a fixed wall bracket on the battery module, and then check to make sure the connections are securely locked.

BMS to Slave1:
B+ to B+ (C:120mm); COMM to COM1
(E:200mm);

BMS to Slave4:
B- to B- (A3:1.2m), Get the cable through
corrugate pipe.

Slave1 to Slave2:
B- to B+ (A1:690mm); COM2 to COM1
(B1:600mm);

Slave2 to Slave3:
B- to B+ (A2:1.2m); COM2 to COM1 (B2:1.2m);

Slave3 to Slave4:
B- to B+ (A1:690mm) and COM2 to COM1
(B2:1.2m).
Get the cables through corrugate pipe.

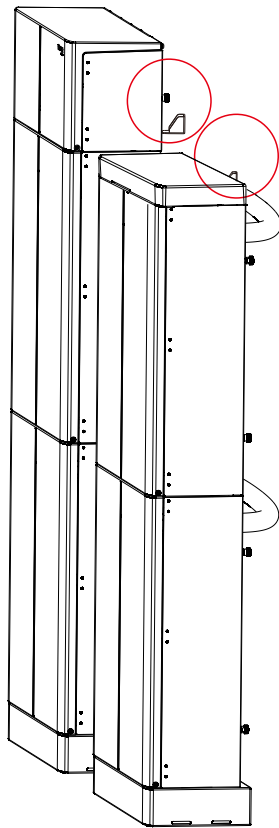

The slave3 or slave4 needs to be grounded, and the user can connect the ground cable to the slave2 or slave1 through the pipe or ground separately according to the local regulations.

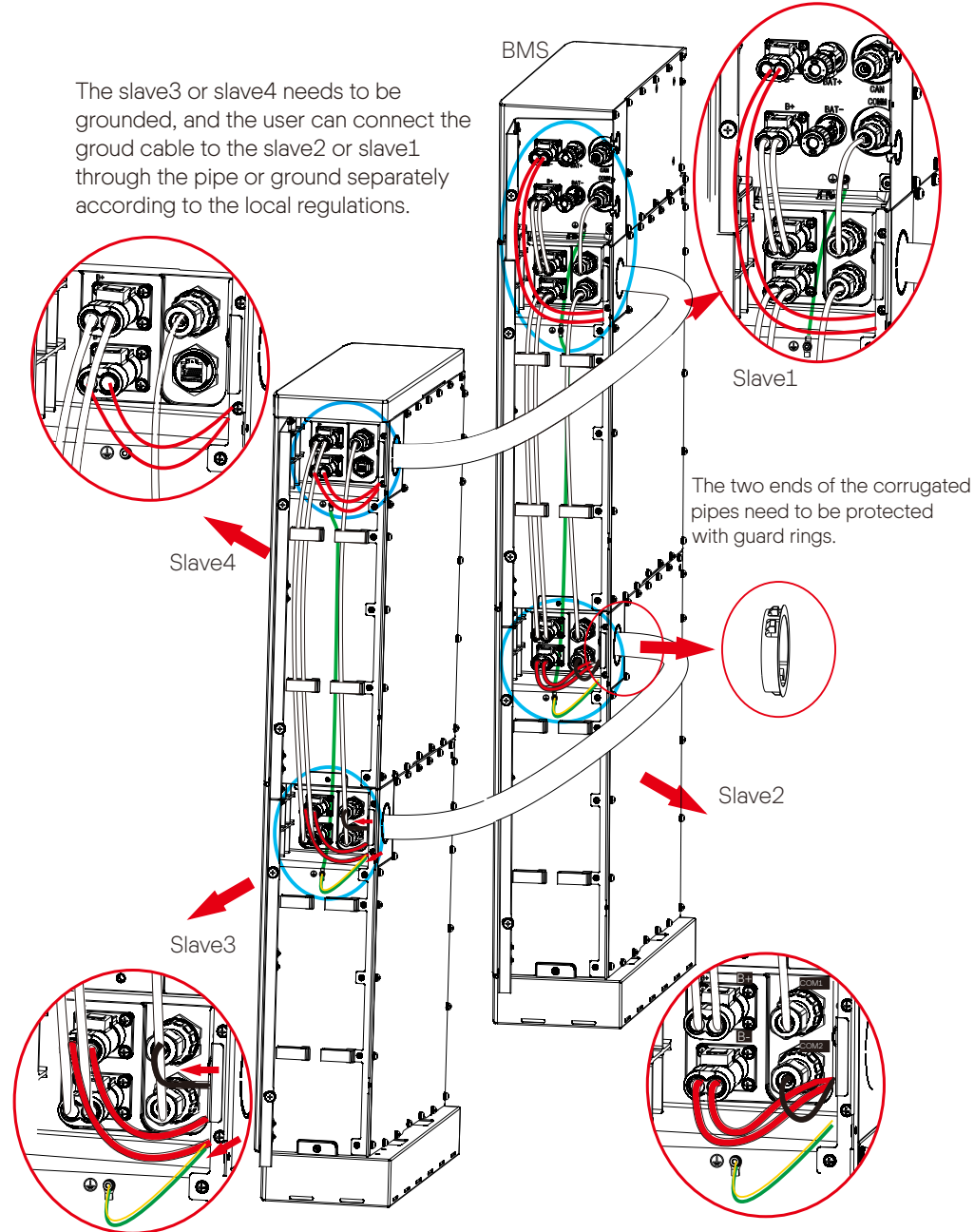

5 Commissioning

5.1 COMMISSIONING

Verify the model number of each battery module to ensure that they are all the same model.

Once all battery module(s) are installed, follow these steps for beginning operation:

- 1) Open the cover board of the BMS
- 2) Move the circuit breaker switch to the ON position
- 3) Long press the POWER button for more than 1s to turn on the T-BAT system
- 4) Turn on the AC switch of inverter

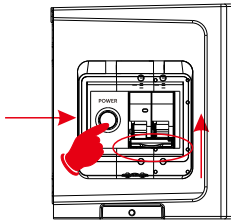

NOTE!

Frequently pressing the POWER button may cause a system error. Wait at least 10 seconds after pressing the POWER button prior to making another attempt.

5.2 Status Indicators

5.2.1 Battery Module (MC0600)

The LED indicators on the front panel of the battery pack are showing the operating status.

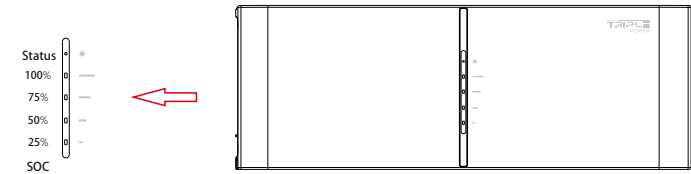

The following table shows the status of BMS.

No.	Status of BMS	Mode
1	Light off	Power off
2	The Green LED is light on for 1s, and light off for 4s	Inverter sends Idle command
3	The Orange LED is light on for 1s, and light off for 4s	BMS Protection
4	The Red LED keeps lighting on for 10min, then flickers with light on for 1s, and light off for 4s	Fault
5	The Green LED is light on for 0.3s, and light off for 0.3s	Upgrade for BMS
6	The Green LED keeps light on	Active

The capacity indicators show the SOC:

- When the battery pack is neither charging nor discharging, the indicator lights are off.
- When the battery pack is charging, part of the Blue LED flashes with the frequency of light on for 0.5s, light off for 0.5s, and part of the Blue LED keeps light on. Take SOC 60% for instance, in charging state:
 - 1). The first two Blue LED indicators keep on
 - 2). The third Blue LED indicator flashes once every 1s
- When the battery pack is discharging, the Blue LED flashes with the frequency of light on for 1s, and light off for 4s. Take SOC 60% for instance, in discharging state:
 - 1). The first three blue LED indicators flash once every 5 seconds

5.2.2 Battery Module (HV10230)

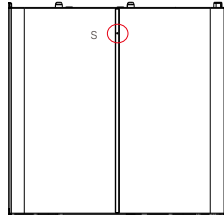

S represents independent status indicators. The status of S has the same meaning for battery modules in the following table.

Note: The battery system is active only when both S are flashing in Green LED every 5 seconds.

No.	Status of battery module	Mode
1	Green LED flashes once every 5 sec	Active
2	Yellow LED flashes once every 5 sec	Protection
3	Red LED flashes once every 5 sec	Fault
4	Red, Green and Yellow LED flash alternately	Upgrade for the BMS

5.3 Shutting Down T-BAT System

To shut down the system, follow the steps described below:

- 1) Turn off the breaker between the inverter and T-BAT System
- 2) Long press 10s to shut down the BMS
- 3) Turn off the system by moving the circuit breaker switch to the OFF position
- 4) Ensure that every indicator on the T-BAT system is off
- 5) Disconnect the cables

**NOTE!**

After powering off the BMS, the LED lights for S will keep flashing for 20 minutes.

6 Troubleshooting

6.1 Troubleshooting

Check the previous indicators to determine the status of the T-BAT system. A warning state is triggered when conditions such as voltage or temperature exceed the design limitations. T-BAT system's BMS periodically reports its operating state to the inverter.

When the T-BAT system falls outside the prescribed limits, it enters into a warning state.

When a warning is reported, the inverter immediately stops its operation.

Use the monitoring software on the inverter to identify what caused the warning.

The possible error messages are as follows:

Error Messages	Description	Troubleshooting
BMS_Ver_Unmatch	The version of BMS is unmatched	Contact your distributor or SolaX directly for servicing.
BMS_Internal_Err	1) DIP switch on the wrong position 2) The communication between battery modules is interrupted.	1) Move the DIP switch to the correct position 2) Check if the communication cable between the battery modules is correctly and properly connected.
BMS_OverVoltage	Battery over voltage	Contact your distributor or SolaX directly for servicing.
BMS_LowerVoltage	Battery under voltage	Contact your distributor or SolaX directly for servicing.
BMS_ChargeOCP	Battery charge over current protection	Contact your distributor or SolaX directly for servicing.

Warning Messages	Description	Troubleshooting
BMS_TemHigh	Battery over temperature	Wait until the temperature of the cells returns to the normal state.
BMS_TemLow	Battery under temperature	Wait until the temperature of the cells returns to the normal state.
BMS_DischargeOCP	Battery discharge over current protection	Contact your distributor or SolaX directly for servicing.
BMS_Hardware_Protect	Battery hardware under protection	Contact your distributor or SolaX directly for servicing.
BMS_Insulation_Fault	Battery insulation fault	Contact your distributor or SolaX directly for servicing.
BMS_VoltSensor_Fault	Battery voltage sensor fault	Contact your distributor or SolaX directly for servicing.
BMS_TempSensor_Fault	Battery temperature sensor fault	Contact your distributor or SolaX directly for servicing.
BMS_CurrSensor_Fault	Battery current sensor fault	Contact your distributor or SolaX directly for servicing.
BMS_Relay_Fault	Battery relay fault	1) Ensure the power cable is correctly and properly connected to the power connector (XPLUG) of the BMS 2) If the first step still does not work, contact your distributor or SolaX directly.
BMS_Type_Unmatch	The type of BMS is unmatched	Contact your distributor or SolaX directly for servicing.

7 Decommissioning

7.1 Dismantling the Battery

Shutting down the battery unit

- Disconnect the cables between the BMS and inverter
- Disconnect the series wiring terminal on the battery
- Disconnect the cables

7.2 Packing

Pack the BMS and battery modules in the original packaging.

If the original packaging is no longer available, use an equivalent carton or box that meets the following requirements:

- Suitable for loads over 154.32lb
- Properly closed and sealed

8 Maintenance

-If the ambient temperature for storage is -4 - 11.3°F , recharge the batteries at least one time every 3 months.

-If the ambient temperature for storage is -4 - 68°F , recharge the batteries at least one time every 6 months.

-If the battery is not used for more than 9 months, the battery must be charged to at least SOC 50 % each time.

-When installing the battery for the first time, the manufacturing date between battery modules should not exceed 3 months.

-If the battery is replaced, the SOC between the batteries used should be as consistent as possible, with a maximum difference of $\pm 5\%$.

-If you want to expand your battery system capacity, please make sure your existing system capacity's SOC is about 40%. The expansion battery is required to be manufactured within 6 months; If more than 6 months, recharge the battery module to about 40%.

9 Disclaimer

Triple Power protects this product under warranty when it is installed and used as listed in this manual. Violation of the installation procedure or use of the product in any way not described in this manual will immediately void all warranties on the product.

Triple Power does not provide warranty coverage or assume any liability for direct or indirect damages or defects that result from the following causes:

- Force majeure (flooding, lightning strike, overvoltage, fire, thunderstorm, flooding etc.)
- Improper or noncompliant use
- Improper installation, commissioning, start up or operation (contrary to the guidance detailed in the installation manual supplied with each product)
- Inadequate ventilation and circulation resulting in minimized cooling and natural air flow
- Installation in a corrosive environment
- Damage during transportation
- Unauthorized repair attempts
- Failure to adequately maintain the equipment. An on-site inspection by a qualified technician is possible following 120 months of continuous use. Warranty claims made beyond 120 months from date of commissioning may be declined if it cannot be demonstrated that the equipment has been adequately maintained
- External influence including unusual physical or electrical stress (power failure surges, inrush current, etc.)
- Use of an incompatible inverter or devices
- Connect to other brands inverters without authority from Solax